

CNC4you

Practical knowledge for the shopfloor



Complete
machining has
never been easier

New functions for multi-tasking
machines

Digitalization for the shopfloor

Tailor-made portfolio for small and medium-
sized businesses

Logging made easy

Sinumerik high-level programming language:
The WRITE command



4 The new Version 4.7 of the Sinumerik Operate software significantly simplifies the programming and operation of multi-tasking machines

Siemens AG



18 South African CNC machine tool supplier W.D. Hearn has installed ncTOUCH software as a standard feature on all Leadwell CNC machines with Sinumerik 828D

Siemens AG



24 Students at Trier University of Applied Sciences are trained using modern machine tools equipped with Sinumerik 840D sl

Siemens AG

Cover photo: Siemens AG

Publisher
Siemens AG
Division Digital Factory
Gleiwitzer Straße 555,
D-90475 Nürnberg
siemens.com/digital-factory

Division Digital Factory
CEO Anton S. Huber

Editorial responsibility in accordance with the German press law
Bernd Heuchemer

Responsible for technical content
Hans Pischulti

Editorial committee chairs
Karsten Schwarz, Andreas Grözinger

Publishing house
Publicis Pixelpark Erlangen
P.O. Box 32 40,
91050 Erlangen, Germany
Editor: Gabriele Stadlbauer

Copy Editor: Julia Robinson
Layout: Michael Schrödel

DTP: TV Satzstudio, Emskirchen
Print: Wünsch Offset-Druck GmbH,
Neumarkt/Opf.

Article No.: E20001-A1840-P610-X-7600

Circulation: 9,000

★ EMO

- 04 Complete machining has never been easier**
New functions for operating and programming multi-tasking machines
- 07 Top-level Sinumerik training**
TAC for machine tools in Piacenza
- 08 Digitalization for the shopfloor**
Tailor-made portfolio for small and medium-sized businesses
- 10 Improved usability**
New functions for Sinumerik Operate
- 12 Working efficiently with two tools**
Four-axis turning with Sinumerik
- 14 Economic efficiency as a success factor**
The right spindle drive for the machine tool



On the shopfloor

- 18 Control improves productivity**
Optimal machine monitoring with ncTOUCH
- 20 Dual role**
Technology and financing expertise from a single source



Tips & tricks

- 22 Logging made easy**
Sinumerik high-level programming language: The WRITE command



Education

- 24 Teaching and practice — hand in hand**
Trier University of Applied Sciences teaches students using Sinumerik CNC and NX software



News

- 26 eBooklet for EMO 2015 / EMO trade fair show — smart operation**
- 27 Successful spindle workshop / New learning factory with Sinumerik**

© 2015 by Siemens Aktiengesellschaft
Munich and Berlin
All rights reserved.

This issue was printed on paper made from environmentally friendly chlorine-free bleached pulp.

The following products are registered trademarks of Siemens AG:

SHOPMILL, ShopTurn, SINAMICS, SINUMERIK, SINUMERIK 828, SINUMERIK 840, SINUTRAIN

If trademarks, trade names, technical solutions, etc., are not referred to specifically, it does not mean that they are not protected. The information in this journal only includes general descriptions and/or performance characteristics, which do not always apply in the form described in a specific application, or which may change as products are developed. The required performance characteristics are only binding if they are expressly agreed at the point of conclusion of the contract.



Dear readers,

The focus of this year's EMO in Milan is the **ongoing digitalization** of the machine tool world. Digital technology, such as networked machines, innovative operating concepts and mobile devices, allows production workflows to be optimized. With **smart operation**, Siemens demonstrates that digitalization and integrated production can be an ideal solution, even for shopfloor applications. Thanks to computer-based work preparation, paperless production, and the ability to call up current machine statuses on a smartphone or tablet, even small companies can make their production more flexible and efficient.

In Milan we will also be presenting our **enhanced Sinumerik hardware and software**, which facilitates even greater productivity in turning, milling, grinding and five-axis milling. The **improved operating concepts in Sinumerik Operate**, for example, make operation on the control system even easier and safer than before. And, with innovative cycle functions, workpieces can be machined even more quickly and precisely.

Sinumerik Operate has also been enhanced with user-friendly functions for **complete machining**. As all functions for milling and turning are now integrated in a single system, even turning on a milling machine is easier than ever before. Visitors to the Siemens booth at EMO can see for themselves the **advantages of multi-tasking machining** live on a five-axis machine from the Italian manufacturer MCM.

Visit us at our booth in Hall 3 at EMO and find out about all the new Sinumerik developments. It will be worth your while!

Claudio Jans
Applications Engineer
Siemens Technology and Applications Center (TAC)



New functions for operating and programming multi-tasking machines

Complete machining has never been easier

Siemens is significantly simplifying the operation and programming of multi-tasking machines. The new software, Version 4.7, of the user interface Sinumerik Operate standardizes the look and feel of machining across a range of technologies. This makes it easier for machine operators to switch between turning and milling machines and provides direct, intuitive access to complex complete machining processes.

Multi-tasking machines are capable of implementing multiple production technologies, such as turning, milling, drilling and measuring, thus enabling the complete machining of workpieces in a single clamping. Repeated reclamping becomes a thing of the past and the efficiency and precision of production are increased. The Sinumerik 840D sl CNC has already integrated all the functions required for sophisticated complete machining: a milling spectrum from high-performance machining centers for powertrain production in the automotive industry to highly dynamic five-axis machining centers for mold construction in the aerospace industry. The turning spectrum ranges from multi-channel five-axis turning centers with b-axes to high-performance multi-spindle applications.

Closing the gap in the multi-tasking segment

Multi-tasking machine operators are expected to be able to both program and operate all the production processes available on their machines. However, the

traditional training for cutting machine operators usually concentrates on a technology-specific field, such as turning or milling. The new Version 4.7 software of the user interface Sinumerik Operate closes this gap. The intuitive cross-technology operation and programming make all the multi-tasking machine's machining processes available to specialist staff. With the new functions in Version 4.7 of the software, the user can take advantage of the high productivity of complete machining in production — even for shopfloor-oriented production, in conjunction with job shop programming.

User-friendly — from set-up to tool management

With the new Sinumerik Operate, the turning functions for milling and the milling functions for turning are perfectly combined in a single interface. The turning and milling tools and the turning and milling cycles are automatically adjusted to suit the given form of machining and respective machining plane. The tool lengths are also taken into account and displayed accordingly. One extremely practical enhancement is that complete turning functionality is now also available in ShopMill.

The intelligent JOG mode in Sinumerik Operate provides graphical, interactive support to users setting up turning machines and turn-milling machines. A tool can therefore be loaded easily by pressing just three buttons. In addition to the existing option to choose between technologies such as face milling or chip removal, there are now new functions for multi-tasking machines. Unproductive time is thus reduced to an absolute minimum. In addition, optimum support is provided for tool measurement in JOG mode. In the new function for multi-tasking machines, a measurement function for turning tools is available, which makes it possible to measure turning tools while they are engaged. The mask changes depending



Siemens AG

on the tool type to be measured. In JOG mode, the TSM area has also been expanded to include the positioning of turning tools. Once the user selects a turning tool, the machine is switched to turning mode.

Another highlight of Sinumerik Operate is the clearly arranged Sinumerik tool management. To facilitate efficient management of tool data in complete machining, the functionality has been expanded so that users can view the tool and magazine data for milling and turning tools, including all the details, in a single image. Input is performed simply by means of parameters. The turning tools are presented as icons, and complex tools such as multi-tools are supported, thus significantly simplifying operation for the user.

Expanded cycle functions for perfect results

By using innovative cycles that perform exceptionally well in multi-tasking machines thanks to their standardized usability, comprehensive work steps in complex machining operations can be resolved more easily. The Cycle800 swivel cycle, for example, is also easy to operate and understand when combining turning and milling technologies. With the aid of swivel heads or swivel tables, this cycle can be used to machine and set up inclined planes — both manually and automatically.

In addition, turning cycles have been expanded in programGUIDE to facilitate easy operation of complex multi-tasking machines. A graphical contour calculator helps the user with input, and parameterization is performed easily via a dialog. Engaged tools can be graphically and interactively programmed with ShopTurn and the b-axis. During this operation,

The positioning of the turning tool is shown as an option on the screen for the active turning tool selected



Siemens AG

The Cycle800 swivel cycle perfectly combines turning and milling technologies in a single interface

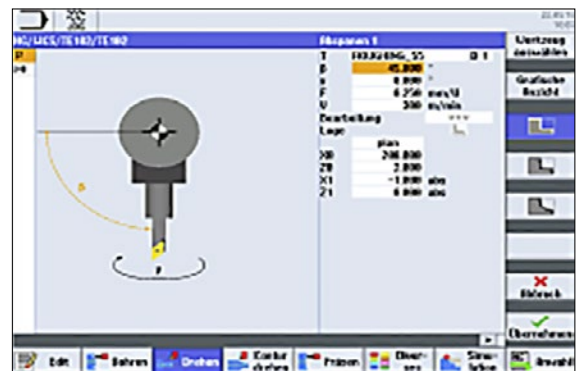

Siemens AG

the setting angle of the b-axis (β) and the positioning angle of the tool spindle (γ) are indicated directly in the technology area of the cycle. Milling operations on turning machines are also possible with ShopTurn and the b-axis. Machining operations on the face or lateral surface are defined by selecting the plane in the cycle, while milling on swiveled planes is performed with the Cycle800 swivel cycle. All milling ►

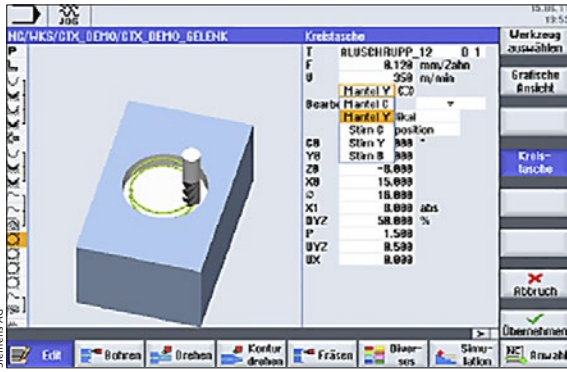

All milling cycles on the turning machine are identical to those in ShopMill

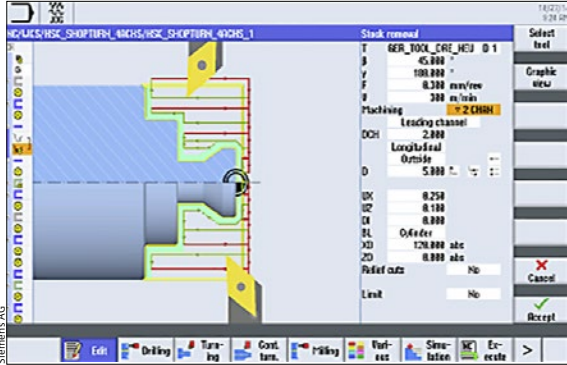

Cycle952 now also allows for four-axis chip removal on multi-channel turning machines

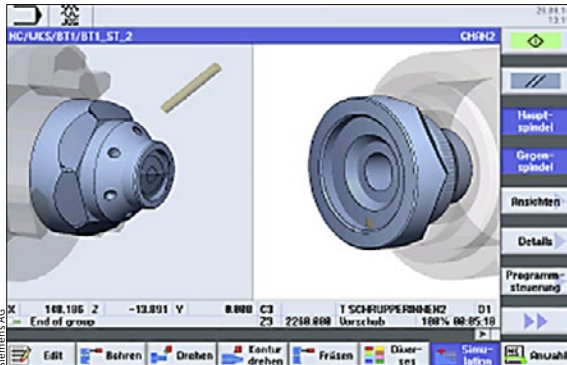

3D removal simulation is also possible for workpieces with inclined surfaces

cycles on the turning machine are identical to those in ShopMill. Alternatively, the user can perform milling operations with programGUIDE and the b-axis. To do this, Cycle800 is selected with the "swivel plane" function, for example, and a new machining plane is generated, on which all milling functions can be created, also with the help of cycles.

The Sinumerik's Cycle952 contour machining cycle now allows for four-axis stock removal on multi-channel turning machines. Powerful functions facilitate workpiece machining. For example, automatic residual material detection ensures optimum cut segmentation, and automatic feed interruption guarantees that the chip breaks evenly and can thus be precisely removed. As an optional addition, the interpolation turning cycle is available for longitudinally or transversely machining corners on inner or outer contours.

Sinumerik also features powerful functions for five-axis machining that considerably simplify the entire process of multi-axis programming and machining, such as TRAORI tool-center-point programming, orientation smoothing while milling with ORISON, or the 3D tool radius compensation CUT3DC — CUT3DF.

Process reliability through simulation

Virtually checking production processes before machining helps prevent errors and optimizes machining times. Whether on face and lateral surfaces, on swiveled workpiece planes or when machining in multiple machining channels, the simulation demonstrates the complete machining of the workpiece. In multi-tasking machines, milling and turning technologies as well as workpiece measurement can be simulated simultaneously. At the same time, a 3D removal simulation is also possible for workpieces with inclined surfaces (3+2-axis machining) or free-form surfaces (3-5-axis machining). If milling machines have multiple rotary axes that can be used as spindles for turning, the clamping parameter ensures the correct orientation of the blank and alignment with the simulation. In addition, the mold-making quick view facilitates rapid simulation of programs with free-form surfaces. The sets G0, G1, G2, G3, BSPLINE and POLY are supported, as is the display of vectors for five-axis machining — for both rotary axis programming and vector programming.

State-of-the-art technology

All combinations of the most frequently used production technologies in industry, namely turning, milling, drilling and measuring, are consistently and universally implemented in accordance with the latest technical standards in Sinumerik Operate, both in programming and in operating. A variety of additional technologies, such as grinding, eroding, laser and water-jet cutting, nibbling, honing, slotting, and so on, are also supported. The openness of Sinumerik 840D sl allows these designated production technologies to be integrated into a multi-tasking application, thus increasing efficiency of production.

INFO AND CONTACT

siemens.com/sinumerik-operate
claudio.jans@siemens.com



TAC for machine tools in Piacenza

Top-level Sinumerik training

At the Technology and Application Center (TAC) in Piacenza, instructors are given in-depth training on Sinumerik. In this way, Siemens supports the training at vocational colleges and universities while also providing training sessions for machine manufacturers and dealers. This helps secure the future of the Italian mechanical engineering and manufacturing industries.

The TAC Italy was established in 2011 in Piacenza. Its mission was clearly defined: to train instructors with the aim of disseminating practical knowledge and establishing Siemens' CNCs in training and production, to communicate technical innovations, and to serve as a point of contact in the region. These aspects are becoming increasingly important, particularly in view of the digitalization of the machine tools industry. The TAC also has plans to set up a training and further education network that will work with technical institutions, educational establishments, vocational schools and universities.

From the very start, the TAC's cooperation with universities has been extremely effective. The University of Applied Sciences in Milan, for example, has been offering a single-semester mechanical engineering course at the TAC since 2011, and the University of Applied Sciences in Turin also collaborates with the TAC in Piacenza. In terms

of equipment and facilities, the TAC offers optimum conditions for efficient Sinumerik training. An area covering 700 m² in total contains two training rooms, a large machine shop with a conference room, six machine tools, one robot, and training simulators for the latest Sinumerik and Sinamics products. Machine manufacturers, users and educational providers are making use of the offerings at TAC Piacenza; indeed, more than 600 participants have been trained there already this year. Thanks to the support of various technology partners, the center is able to provide a practical demonstration of the complete range of CNC applications with the six machine tools.

The close collaboration between the certified training partners Istituto Professionale LBS, CNOSFAP, CNOSFAP Bearzi, Assocam Scuola Camerana and Istituto San Gaetano helps ensure sustainable and constantly up-to-date knowledge transfer in CNC training in Italy.

TECHNOLOGY PARTNERS

- > Castrol Industrial
- > Coord3
- > Hoffmann Group Italia S.p.A.
- > Kuka Roboter Italia S.p.A.
- > Project Group
- > Renishaw S.p.A.
- > S.A.M.U. S.r.l.
- > Sequoia S.r.l.
- > Speroni S.p.A.
- > Vega International Tools S.p.A.

INFO AND CONTACT

siemens.com/cnc4you
nicodemo.megna@siemens.com

More than 600 participants a year are trained on Sinumerik CNCs at TAC Piacenza





Tailor-made portfolio for small and medium-sized businesses

Digitalization for the shopfloor

Digitalization has become an essential undertaking in the manufacturing industry, because integrated production increases efficiency and thus competitiveness. With smart operation, shopfloor-oriented companies can now share in the vision of digitalization — in a way that precisely suits their requirements.

smartPrepare

Digitalization, or Industrie 4.0, sounds like something that involves large-scale IT infrastructure and networking of extensive production facilities — in short, something that requires IT expertise and substantial investments. For companies that are more shopfloor-oriented, these terms are often associated with the uncertainty of something that might be just a little too ambitious for them. But it has never been so easy to integrate a machine tool into production processes. With smart operation, Siemens enables small and medium-sized companies to benefit from modern modes of operation in production with minimal effort.

Simple and efficient machine operation

It begins with working on the machine. Whether milling, turning or complete machining, whether in large quantities or small batches, smartOperate provides the operator with many new, extremely useful functions from Sinumerik. In conjunction with Sinumerik 840D sl, for example, the new OP 015 black and OP 019 black operator panels with multi-touch and gesture technology can be used to make operating the control system even more efficient. The user can simply zoom, rotate or move the workpiece across the screen during the simulation using gesture control, and thus check it from all angles before starting the NC program. But smartOperate also offers improved editor functions in Sinumerik Operate. Due to the color display of the programming commands, the user can see at a glance whether a rapid traverse or feed rate was programmed. What's more, the font size on the screen can be made larger or smaller, allowing for a more

SMART OPERATION AT A GLANCE

- > smartOperate: new operating modes with touch technology
- > smartMobile: job status and other information, available via mobile devices
- > smartPrepare: work preparation with SinuTrain
- > smartIT: all documents for a job on the machine

detailed presentation. The cycle view is equally convenient as a work step, as it presents cycles in programGUIDE in exactly the same way as in ShopTurn or ShopMill.

Never lose sight of the machine

Thanks to smartMobile, the operator always knows what is going on, even when he or she is not standing at the machine. This enables the operator to access Sinumerik 840D sl and 828D with any terminal equipment and a standard web browser. Important information, such as the operating state, pending alarms, utilization, tool information and much more, can be displayed at a glance on any PC, tablet or smartphone, for example, enabling rapid intervention in the event of disruptions in production.

What is especially practical is that smartMobile provides executable templates that allow the user to

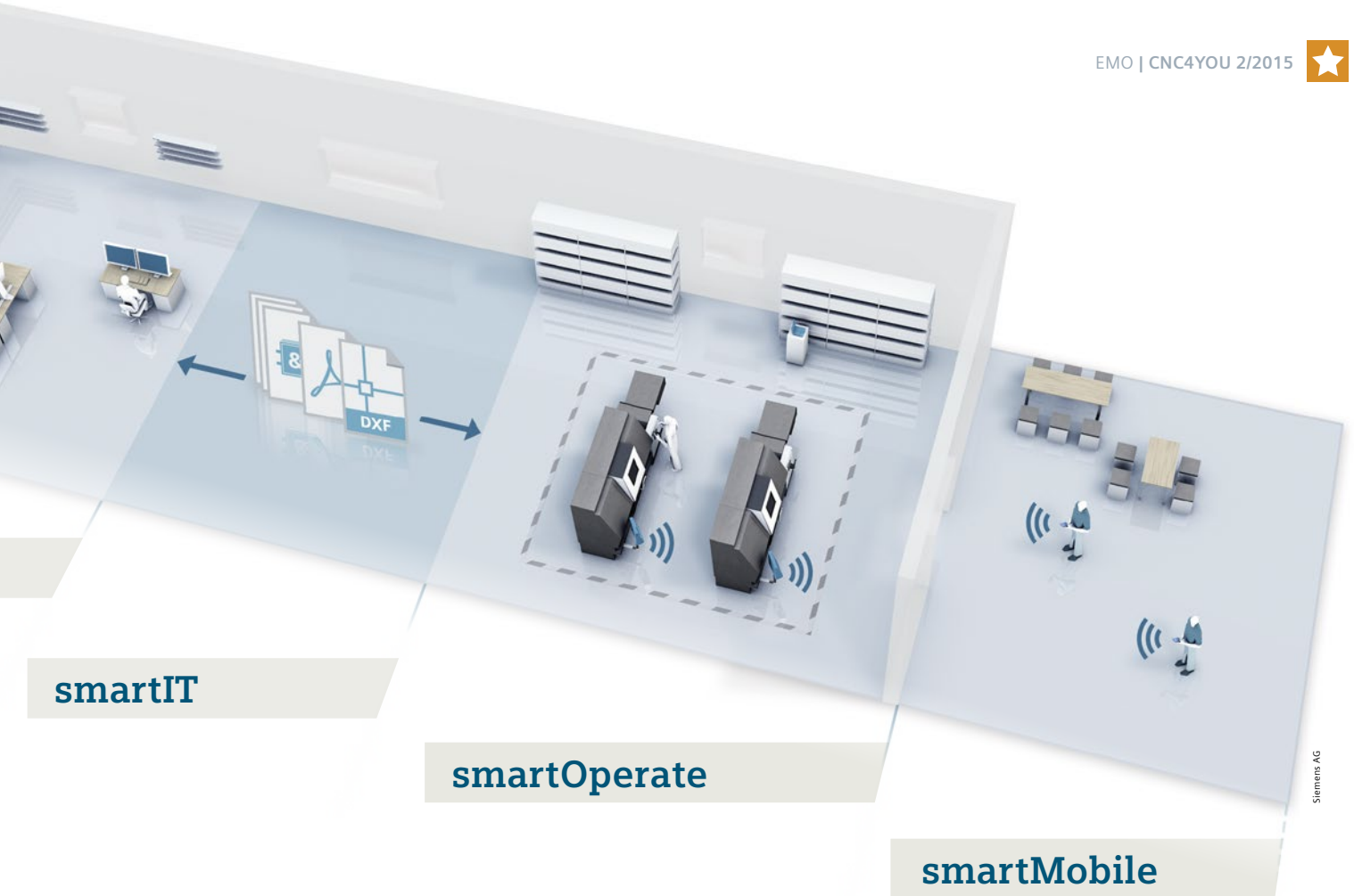

smartIT

smartOperate

smartMobile

Siemens AG

access a great deal of relevant information. These best-practice templates were developed and designed in collaboration with users.

Increased productivity thanks to work preparation

Achieving ever-higher levels of productivity is also necessary in the machine shop sector. With smartPrepare, the next workpiece can be programmed even while the machine is still in use. While the machine is in the process of producing one job, the machine operator can use a SinuTrain station to quickly and easily prepare the next part. With its original Sinumerik CNC kernel, SinuTrain behaves identically on a PC to the Sinumerik CNC, and is therefore ideal not only for professional training but also for reliable offline programming. Several example machines are already preconfigured in the SinuTrain software. And if these examples are not enough, the machine supplier can adapt SinuTrain to the characteristics of the actual machine.

Paperless production is a reality

The only question that remains is how to get the generated data onto the machine. By USB or another storage medium? With the aid of a paper printout? It can now be done much more easily and reliably. With

smartIT, all the order documentation, such as parts programs, DXF drawings and images, is available on the control panel via the network connection. This means there is no longer any need to search for documents. With the EES (Execution from External Storage) function in Sinumerik Operate, any media outside Sinumerik can be accessed in order to display these order documents on Sinumerik or to process them directly. The size and quantity of parts, programs and production data are, therefore, no longer limited by Sinumerik's internal memory; they are virtually unlimited thanks to the use of external memory.

Another important feature for paperless production is the new DXF reader option. If the contour or the positions for drilling patterns no longer need to be programmed entirely on the CNC, and if the data can instead be transferred thanks to the CAD reader, this saves up to 90% of the programming time. DXF files can be opened directly on the CNC and transferred into the CNC program at the click of a mouse. <



INFO AND CONTACT

siemens.com/sinumerik-operate
robert.schuetze@siemens.com

New functions for Sinumerik Operate

Improved usability

Sinumerik Operate, the operating and programming interface for machine tools, has been expanded to include new functions in Version 4.7. Setting the workpiece, programming and program management have been made even more convenient for the user.

Sinumerik Operate offers functions that let the operator visualize measurement when setting up a workpiece. From software Version 4.7, measurement results can now also be logged. Logging these in JOG simply requires pressing the “measurement log” soft key, which appears at the end of the measuring process. A standard log is then generated automatically, containing the measurement results of the

most recently executed measurement variant. However, the user can also simply log the results from measurement cycle functions of automatic programs without any NC writing involved. To do this, the new standard log function must be selected by programming a cycle call-up. Four log types are available: calibrate workpiece measuring probe, calibrate tool measuring probe, tool measurement, and workpiece

measurement. The standard logs are created using HMI support screens that are integrated in the measuring cycle support in the “Program” operating area. When measuring in both JOG and the measuring cycles, the user can export the logs in either text or tabular format. The logs can be stored on external media such as a local drive, USB or network, as well as in the parts program.

Logging in JOG

The following settings are possible on the screen:

- > Log format: “text format” *.txt / “tabular format” *.csv
- > Log data: “new / add”
- > Log storage: “directory” (incl. select directory)
- > Log file name: *.txt or *.csv

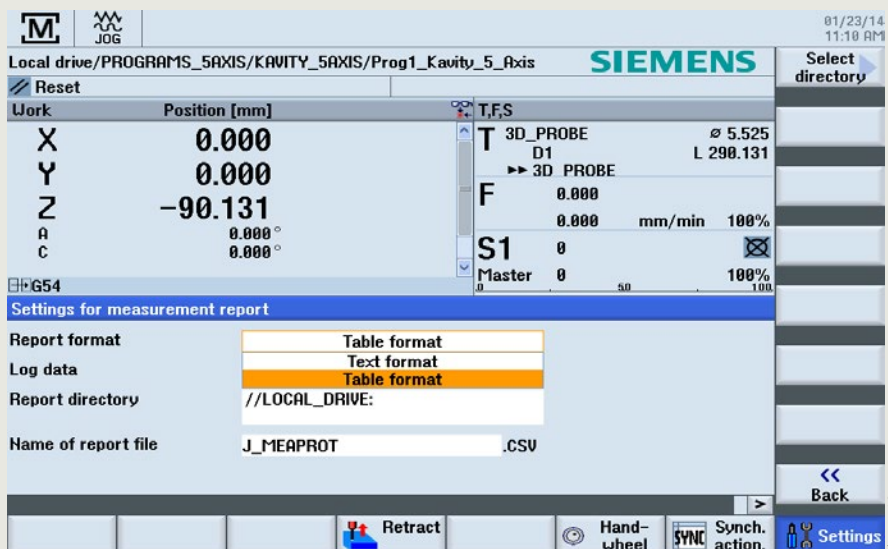

Editor — new functions

Colored highlighting of NC functions:

- > Comments (gray)
- > NC sets / functions (black)
- > Tool call-up / speed... (blue)

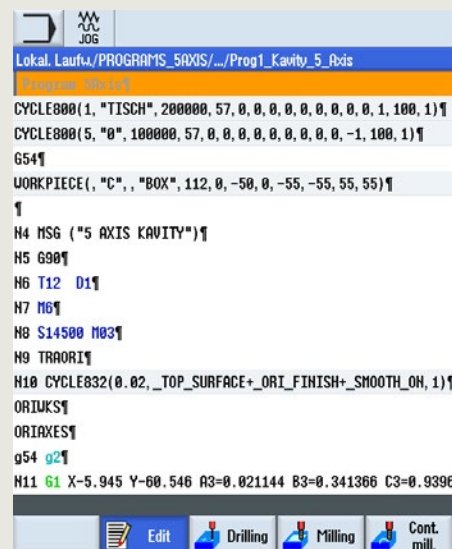



For measurements in automatic mode, Sinumerik Operate provides efficient measuring cycles for any application. In the new software version, the function “align 3D probe in measurement direction” is now also available, allowing for more precise measurement results in case higher precision is required.

Clear programming, more storage space

In Sinumerik Operate, a suitable programming method is available for every area of application — whether ShopMill, ShopTurn or programGUIDE. With the new functions, working with editors is now even more convenient. For better readability of NC programs, the NC functions are highlighted in color in the editor. In the settings screen, the user can define the font size, line breaks and even the cycle presentation on a scalable basis. What’s more, when arranging large programs into blocks, the operator

can now view the blocks on two levels — for even more clarity on the screen. Scalable cycles allow for quick programming in ShopMill and programGUIDE, whereby the user can switch between a complete view and a simplified parametric representation. The new EES (Execution from External Storage) function ensures consistent and simplified program handling: the NC and local drive therefore merge into one, and there is only one program memory. The benefit for the operator: “Extcall,” with the complete path details, is dropped completely, although old programs with “Extcall” will continue to function.

A particular highlight is the added option to also import CAD files directly into the programming in the “programming with the DXF reader” operating area. A Drawing eXchange Format (DXF) file is read in, and contours or drill points are filtered out of it. These are implemented in such a way that they can be understood by the geometry processor or the cycle support in

Sinumerik Operate. DXF files generated in a CAD system can be opened directly in the control system, and contours and points can be extracted at the click of a mouse and then saved as a Sinumerik program. Alternatively, the files can be saved on a network or USB and opened from there like an NC program via the file management system. Last but not least, the user memory in the program management area has been enlarged — from a 2-GB to a 6-GB CompactFlash (CF) memory card — and now offers direct access to user and manufacturer cycles. <

More information on the new Sinumerik Operate Version 4.7 can be found at siemens.com/sinumerik-operate

INFO AND CONTACT

siemens.com/cnc4you
wolfgang.reichart@siemens.com

- > F word — feed (blue)
- > G0 Rapid traverse (red)
- > G1 (green)
- > G2, G3 (teal)

DXF reader: Programming in the contour calculator

The following functions can be performed with the DXF reader:

- > Importing DXF files
- > Fading out graphic layers
- > Automatic contour tracking
- > Using workpiece as the zero point for each contour / drill point
- > Selecting several contours / drill points at the same time
- > Creating and converting contours or drilling patterns for ShopMill, ShopTurn or G-code
- > Displaying created contours / drill points in the geometry processor / cycle support

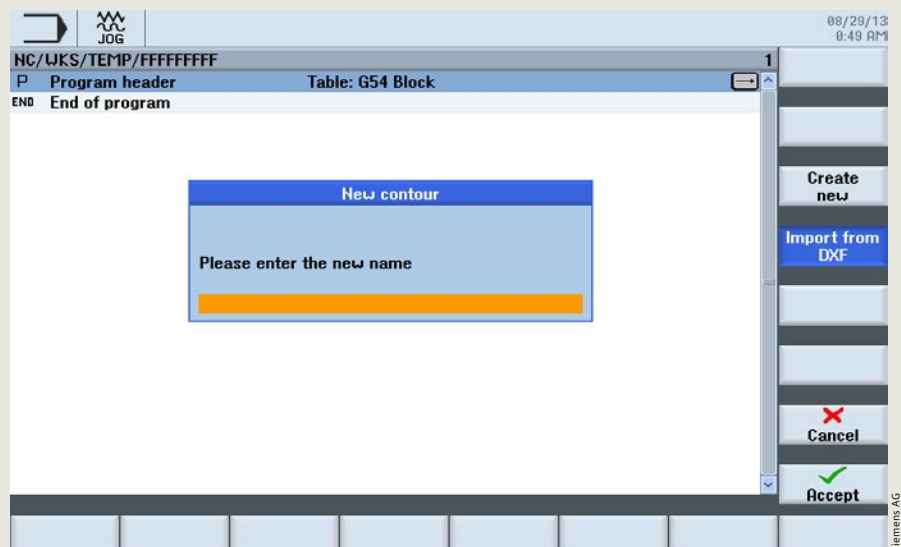
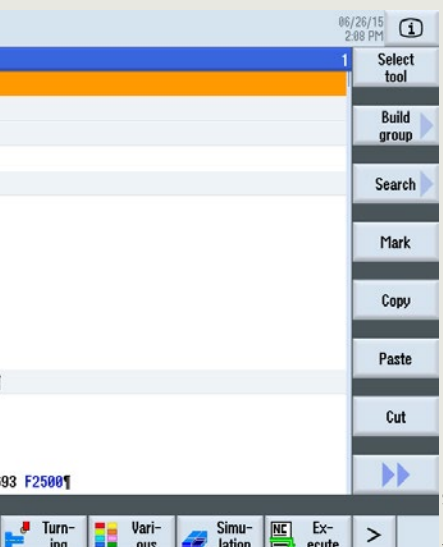

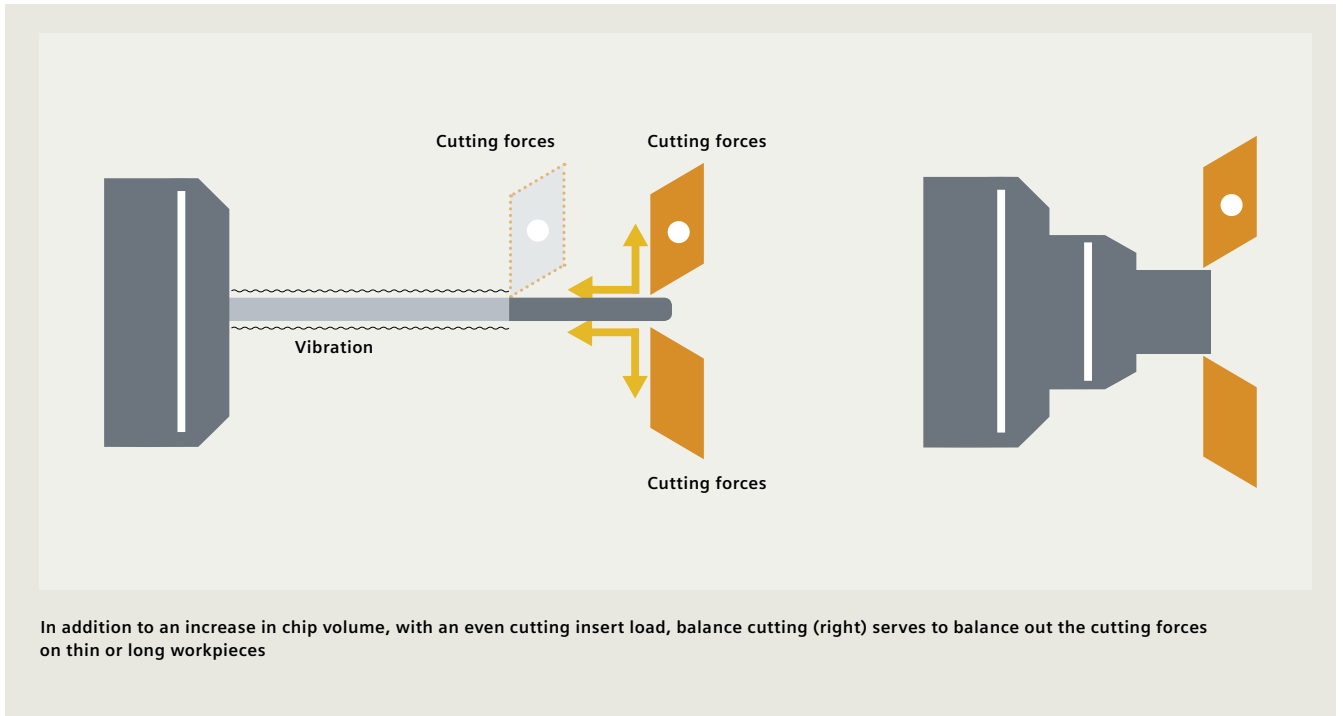

Siemens AG / PublicisKreiplark

Four-axis turning with Sinumerik

Working efficiently with two tools

Tangible productivity advantages — that’s what users gain from machining on the same machining profile simultaneously with two turning tools. Modern CNC controls make it possible to program this highly sophisticated machining task directly on the machine without the need for a CAD/CAM system.

The prerequisite for four-axis turning, also known as balance cutting, is a turning machine with at least two independent tool carriers. As a rule, this involves one tool turret behind the rotation center and a second in front of the rotation center. The machine has to be designed in such a way that both

tool carriers can be engaged on one workpiece simultaneously — one on the main spindle and one on the counter spindle. If both tool carriers are moved independently, two independent CNC programs are executed simultaneously, thus activating a multi-channel structure in the CNC control system.

In this respect, four-axis chip removal can be considered a special form of multi-channel machining: simultaneous machining with two identical tools (for example two 80-degree roughing inserts) on one machining profile of the workpiece. Balance cutting offers two significant advantages compared with



machining using only one cutting insert: First, when machining long, thin components, the balancing of the cutting forces increases the dimensional accuracy, since the use of two opposite cutting inserts eliminates the distortion of the workpiece resulting from the cutting force. Second, the cutting volume per time is increased. There are two possible strategies for achieving these benefits: either synchronous or offset tool path control.

Everything in one channel

In synchronous path control, the cutting inserts are always exactly opposite each other. The two compound slides of the turrets therefore perform exactly the same movement in the respective x and z geometric axes. Because the cutting thickness is distributed equally on both cutting edges, the feed per revo-

lution can be doubled. As a result, the chip volume per time is doubled in comparison with machining using only one cutting edge. But what happens in synchronous path control in the Sinumerik CNC? First, the activation of the tool length corrections and the approach to the machining start point are carried out independently in both CNC channels. Next, the x and z axes of one channel (the following channel) are transferred to the guide channel and carried along position-synchronously. This means that the CNC sets responsible for the machining are processed only in the guide channel, and the following channel remains in the waiting position during the machining. Synchronous path control is equally suitable for roughing and finishing. However, to avoid measuring inaccuracies, the two cutting inserts need to have a tool radius that is as identical as possi-

ble, because the guide channel's tool radius correction also has an effect on the second tool carrier.

Separate CNC positioning sets for each tool

In offset path guidance, the two compound slides carry out different movements. In other words, in longitudinal turning, the cutting inserts work on different diameters, and in face turning, the cutting edges work at offset Z positions. In both cases, this results in a doubling of the effective tool feed rate. Due to the path offset, however, the CNC channels have to be synchronized for each feed, resulting in brief waiting times, which is why the cutting volume per time cannot be exactly doubled compared with machining using only one tool. The offset movements of the two compound slides generally require independent CNC programs in both CNC channels. The two CNC channels are synchronized with each other only during feeds by means of WAIT marks. Because the two cutting tools work with different feeds, offset path control is suitable only for roughing.

Cross-channel CNC programming

In order to enable such complex operations to also be programmed directly on the machine without a CAD/CAM system, Siemens has expanded the proven and efficient Sinumerik Cycle952 contour machining cycle: the contour and the basic cutting parameters now need only to be programmed in the guide channel. What's more, the CNC sequences required for the respective four-axis turning strategy are created fully automatically by the contour machining cycle. With just two parameters "on top," machining with one tool can be extended into highly productive balance cutting with two tools. <

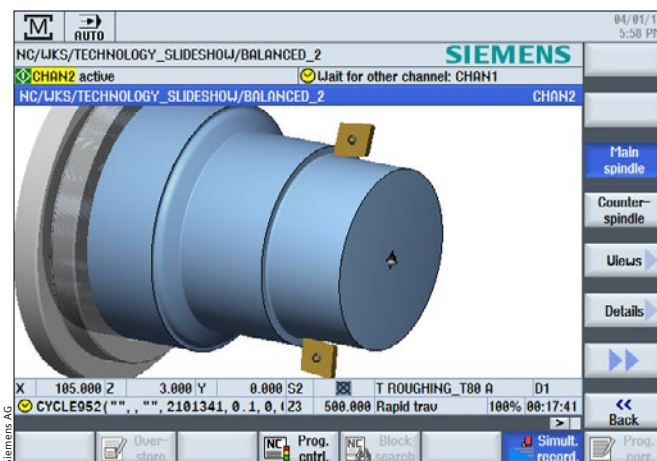

Due to the equal distribution of the cutting thickness on two tools, it is possible to work at twice the feed rate with the same insert load. The chip volume per time is doubled

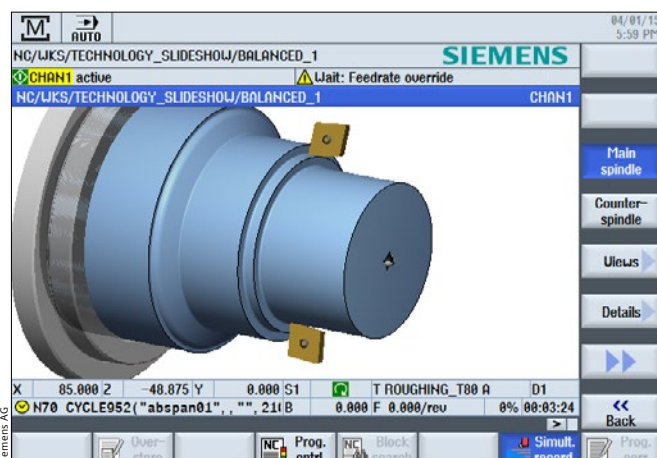

Effectively doubling the feed rate results in almost double the chip volume. Short waiting times are incurred due to the synchronization of the tools for each feed

INFO AND CONTACT

siemens.com/cnc4you
andreas.groezinger@siemens.com

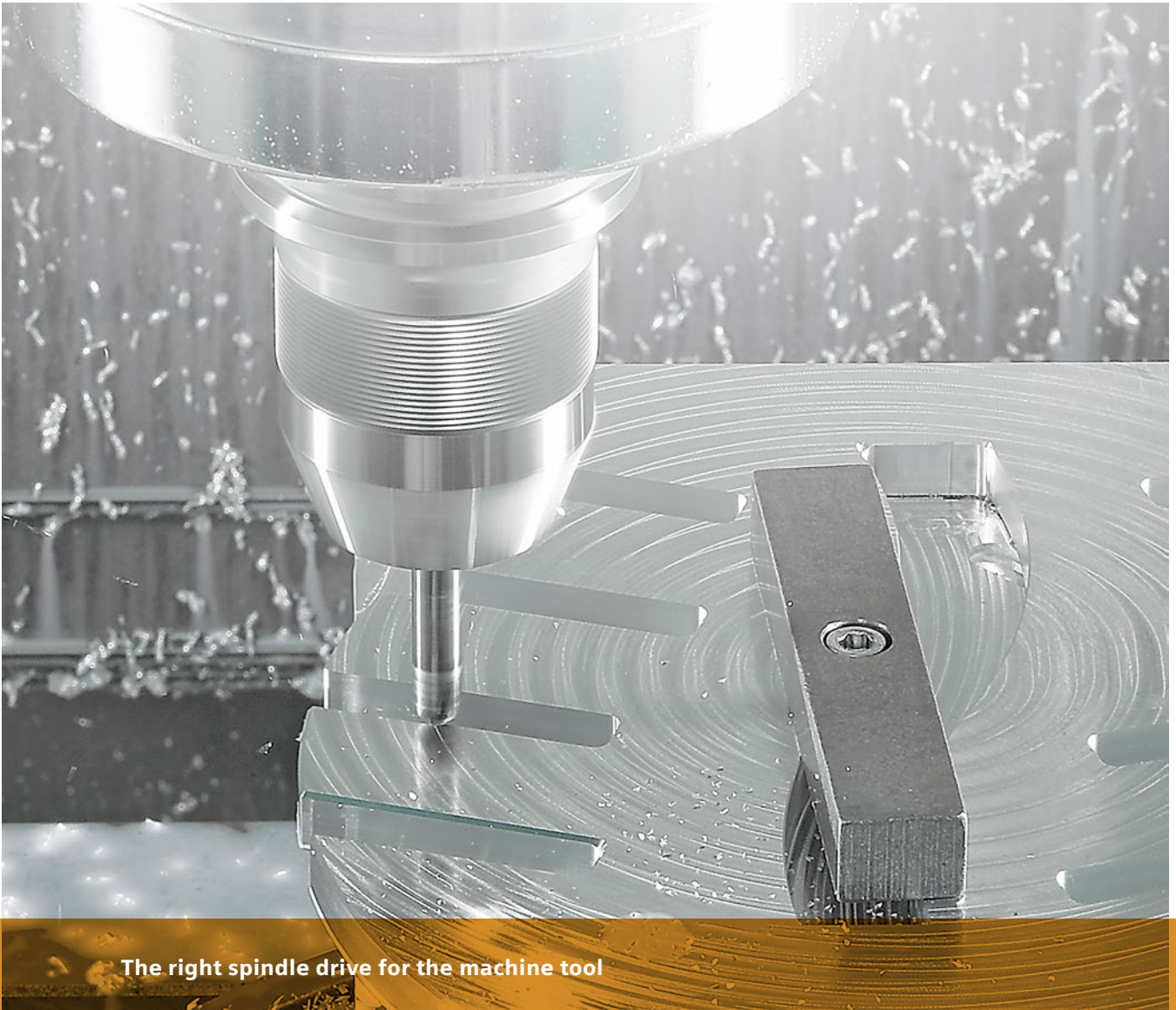

Siemens AG / B. Geisselbrecht

The right spindle drive for the machine tool

Economic efficiency as a success factor

As the heart of the machine tool, the main spindle needs to match the operational requirements as closely as possible. The characteristics required of the spindle are defined not by borderline cases but rather by the predominant machining process. Permanent-magnet motor spindles cover a very wide range of requirements and score highly thanks to their modern rotor designs in permanent-magnet synchronous motors as well as a good balance between lifecycle costs and productivity.

When choosing the right spindles for the machine tool, “bigger and stronger” does not always mean “better and faster.” A sound machine investment is possible only if the concrete requirements for the main spindle are clearly set out and aligned with the basic properties of various spindle drives. In order to determine the right type of spindle, the user must first be clear about several factors: What range of parts will be manufactured? For how many operating hours is the machine likely to be cutting per year? What speed range does the spindle need to cover? Is a high torque also required at high speeds? What maximum power is required — for continuous operation, during brief peak loads or to accelerate? Which productivity criterion is the top priority — throughput, surface quality, precision or availability? Is the production cycle characterized by long roughing phases with a consistent speed or are short clock cycles dominant, in which the ramp-up time of the spindle and the axis dynamics shape productivity? Does the spindle have to control the c-axis operation — and if so, how quick and how precise does the positioning need to be? What are the installation conditions for the machines in question? What space is available?

The machining process determines the main spindle

Clarifying these issues establishes which machining process essentially shapes the machine tool and thereby predetermines the requirements of the main spindle on the new machine. It needs to work with maximum efficiency in this machining process. This is not absolutely essential in the rather rare borderline cases, such as in brief overload operation, with reduced feed rates or with specially optimized tools.

Which spindle is suitable for what?

The most important mechanical spindle variants these days are those indirectly driven (with belt drive), those with a directly mounted motor (mounted spindles) and those with an integrated motor (motor spindles). For all spindle variants, electronic speed regulation by means of a frequency converter is standard. The indirect spindle drive — usually a belt drive — creates a good mechanical and thermal decoupling of spindle and motor. Motor vibrations are damped and transferred to the spindle, so that the spindle requires less cooling. Overall, with this drive, the requirements on the motor are lower than with directly driven spindles — especially since, as a general rule, the belt drive also constitutes a gear stage. Because the motor, spindle and belt drive form mechanically independent units, replacing components is relatively easy. On the other hand,

the belt drive limits the drive rigidity, the dynamic properties, the maximum attainable speed and the energy efficiency of the spindle. The system weight of indirectly driven spindles is always higher than for direct drives. This affects the dynamics of the feed axes — if the spindle unit needs to be moved by the infeed axes. The maximum speed is limited by the lifting of the belt and the restricted pre-tension possibility.

Standard motor spindles versus mounted spindles

In mounted spindles, the spindle shaft and motor shaft lie on one axis and are firmly coupled together. As a result, the control behavior is considerably more

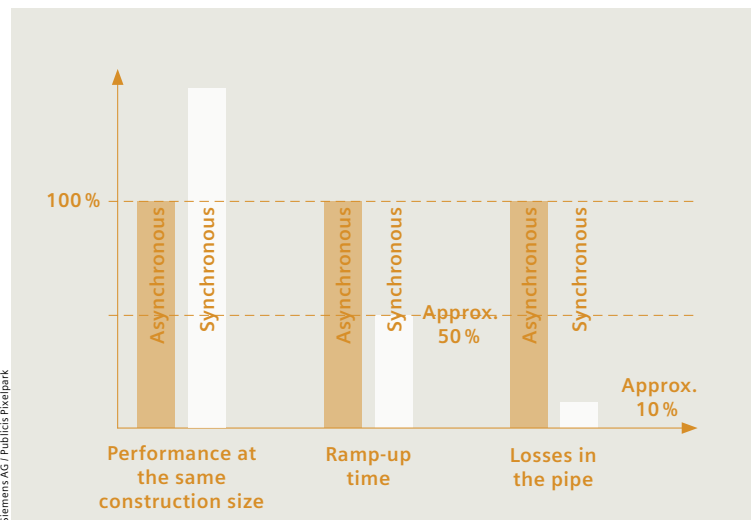

Permanent-magnet (PM) synchronous spindles are increasingly used even in standard machines due to their productivity advantages

rigid than with a belt drive, and transmission losses are also eliminated. What’s more, mounted spindles cover a larger speed range than belt-driven spindles. Due to the longer design, however, they are prone to transverse and torsional vibrations, which limit the dynamics and the maximum speed. The fundamental accessibility of the individual components is similar to that of indirectly driven spindles. Maintenance personnel can therefore also replace the motor or worn parts with ease.

In motor spindles, all the components of the spindle, from the tool holder to the motor, are integrated in a very compact unit. This minimizes the mechanical interfaces as well as the moving inertia, and allows for very high dynamics and rigidity as well as very large speed ranges. The high integration density not only ensures a comparatively low system

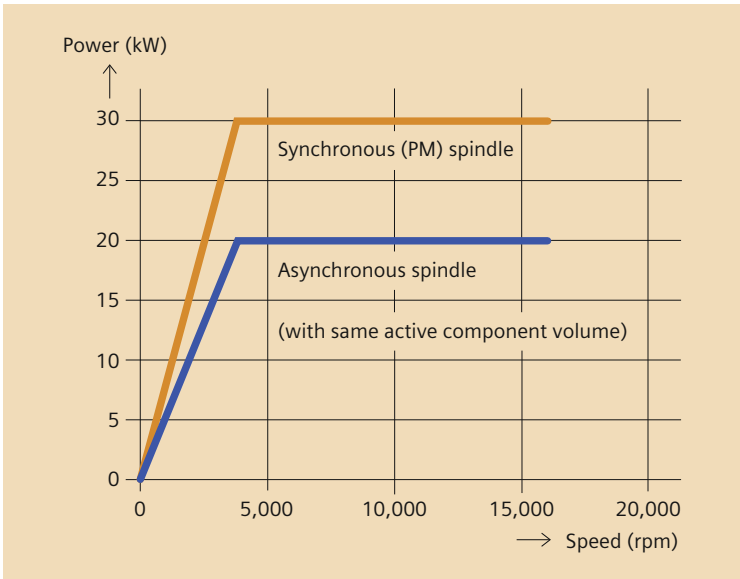

With the same active part volume and the same rated current, PM synchronous spindles have a higher power density than asynchronous spindles and allow for greater torque efficiency

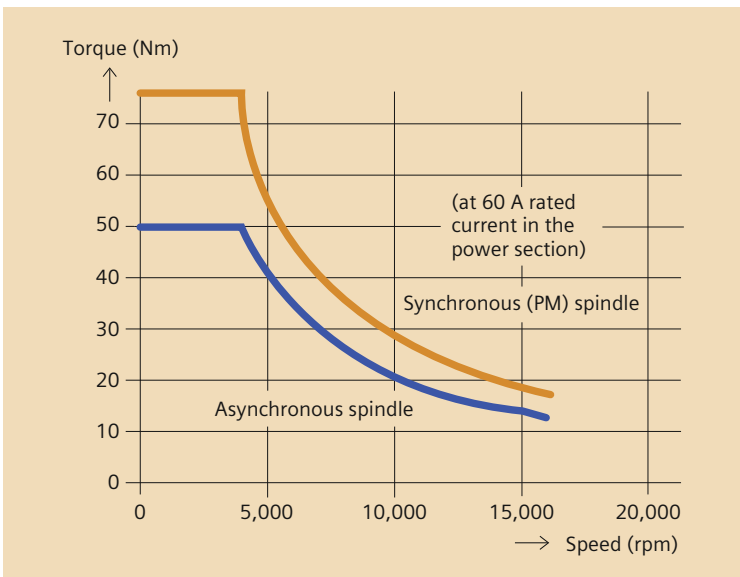

weight but also allows for a quick ramp-up and slowdown, which is particularly advantageous in production processes with frequent tool changes. Due to the high power density, however, the spindle shaft is directly exposed to the waste heat from the motor. The temperature should therefore be kept constantly at the right level using liquid cooling, so as not to impair the manufacturing precision. Although the spindle unit can be quickly swapped

when required, the entire unit has to be replaced at the same time. The costs for stocking spare parts are therefore higher than for other types of spindle, and qualified personnel and special tools are required for repair work. One solution is to use standard motor spindles, which make up for these disadvantages: overall, motor spindles very often allow for significant productivity increases. They are now no longer available only for top-range machines but also for standard machines.

High-quality bearings guarantee precision

A spindle's bearings have a major influence on the manufacturing precision, service life and maintenance costs of a machine tool. In addition to the precise guidance of the spindle shaft, they also help to damp vibrations and reduce rattling during machining. The friction in the bearing has a direct influence on its temperature, wear and service life, as well as the dynamics and efficiency of the spindle.

In practice, very high-quality roller bearings, right through to ceramic bearings, are usually used in both indirectly and directly driven spindles. The expense entailed in hydrostatic or electromagnetic bearings is justified only for extreme requirements in terms of precision and maximum speed, since additional units are required for their operation.

Good price/performance ratio scores high

Alongside the spindle type, the motor technology is another key factor in defining the spindle. For the spindle drive, the user has the choice of three-phase motors with asynchronous technology or permanent-magnet (PM) synchronous technology. Both motor types have a large speed range in combination with a frequency converter, meaning that in most cases a gearbox is unnecessary.

With a low price; a simple, robust design; and low maintenance costs, the speed-controlled asynchronous motor is the most common spindle drive. When it is operated on a servo converter, its speed can be precisely controlled across a wide adjustment range, independent of the load — depending on the design of the motor winding and the type and quality of the bearings. However, the dynamics of a three-phase asynchronous motor are limited by the inertia of the rotor, since it carries a high-mass laminated core with a short-circuit cage. The usable torque drops rapidly as the speed increases in the field-weakening range.

PM synchronous motors, on the other hand, include high-performance magnets on the rotor. Their low mass makes for very high rotor dynamics and allows for compact designs with a high power density. PM synchronous motors also generate productivity ben-

ADVANTAGES AND DISADVANTAGES OF SPINDLE DRIVES AT A GLANCE

	Advantages	Disadvantages
Three-phase asynchronous spindle	<ul style="list-style-type: none"> > High speed capability in operation on frequency converter; large field-weakening range > Comparatively low production costs, especially for high performance > Short-term overload capacity > No overvoltage protection required in generator operation > Reduction of motor current due to star/delta switching > Speed change by pole changing in special designs 	<ul style="list-style-type: none"> > Lower torque density > Lower dynamics due to higher rotor inertia > A quickly dropping torque in the field-weakening range > Approximately 20%–30% more volume than comparable PM synchronous motors, especially in small versions > Lower efficiency at high torque utilization than with PM synchronous motors
PM synchronous spindle	<ul style="list-style-type: none"> > Large continuous torque > Small moment of inertia — high dynamics > High short-term overload capacity > High acceleration capacity > High efficiency and low power loss > Lower rotor temperature > Advantages when positioning due to low weight / moment of inertia (c-axis operation) 	<ul style="list-style-type: none"> > Higher costs due to magnet material > Complex control of field weakening (field weakening current required) > Special tools and trained personnel required for assembly (magnetic forces) > Depending on the size and speed, an overvoltage protection device may be necessary

efits thanks to their large continuous torque, very dynamic speed changes, very rigid control behavior and short-term overload capacity. Due to their high power density, the total mass of the spindle can be kept low. The dynamics of the feed axes can therefore be used for the actual machining. Although using a PM synchronous motor is often associated with higher investment costs — due to expensive magnet material, complex control of the field weakening and the required overvoltage protection for generator operation — the far-reaching productivity

benefits outweigh this disadvantage. That's why even many standard machines are offered with the option of a PM motor spindle. <

 INFO AND CONTACT

siemens.com/cnc4you
juergen.klingler@siemens.com



Optimal machine monitoring with ncTOUCH

Control improves productivity

W.D. Hearn, a highly specialized CNC machine tool supplier in South Africa, provides a vast array of experienced technical support and customer service throughout the country. The company was established in 1937 and currently has service center branches in the four major cities of South Africa.



W.D. Hearn Machine Tools represents major international machine tool manufacturers, such as Leadwell, FFG, Kitamura and Tornos, and is consistently up to date with the latest machine tool developments and current technology trends. Whether for contract manufacture or large-scale production, the company understands its customers' needs and provides professional and tailored advice.

The client base ranges from small and medium-sized companies to high-end automotive engine manufacturers. The core business is the sale and supply of CNC machining and turning centers. W.D. Hearn has built a relationship with Siemens spanning nearly eight years and imports 80% of its CNC machines with the Sinumerik 828D control system. The machine tool distributor is confident that Sinumerik CNCs are the best solution for the South African market in terms of both functionality and price.

New partnership

An inquiry from Daliff Precision Engineering, a major client in the Western Cape province of South Africa, which specializes in high-end aerospace part

manufacturing, resulted in new challenges for W.D. Hearn. Daliff has already purchased numerous CNC machines from W.D. Hearn; the latest three to be installed were Leadwell machines equipped with Sinumerik CNCs.

In addition to CNC machining, Daliff had been looking for a solution to monitor data from its CNC machine park, data needed to help improve its manufacturing processes as well as the accuracy of quotes and the overall part manufacturing time. The company needed a

way to monitor everything on its CNC machines — from tool life and job setup time to tool setting time and even the comparative production rates of night shift versus day shift.

Real-time data with direct access

At the TIMTOS machine tool trade fair in Taiwan, W.D. Hearn learned about ncTOUCH software at the Siemens booth. The software, from Siemens solution partner Mill IT, is capable of

W.D. Hearn has installed ncTOUCH software as a standard feature on all Leadwell CNC machines with Sinumerik 828D



W.D. Hearn

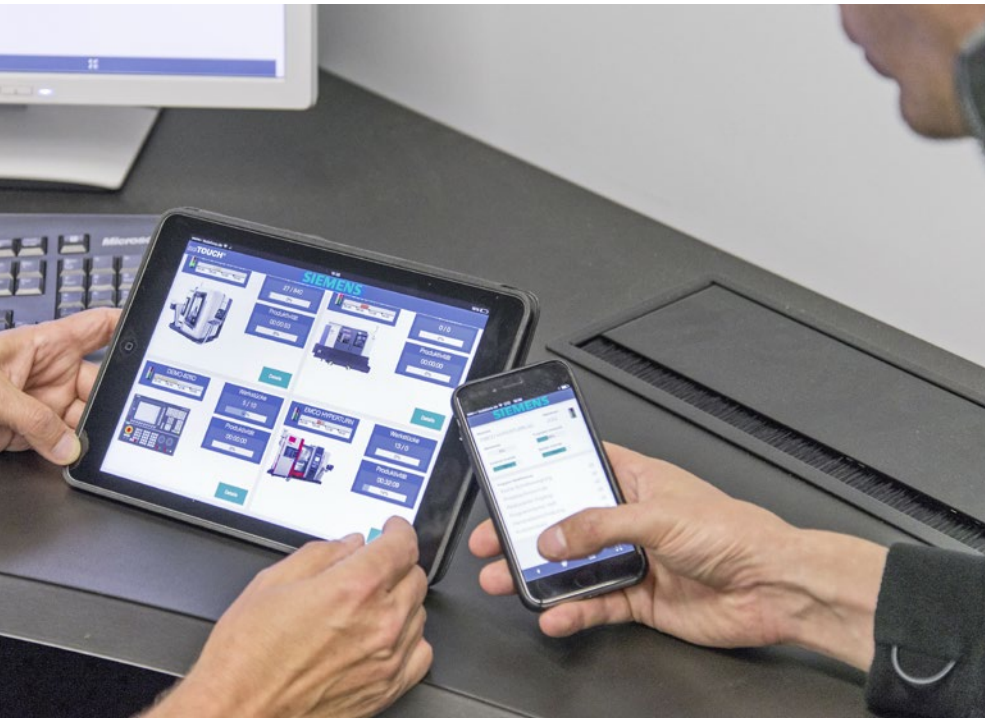

Siemens AG

With ncTOUCH, real-time data can be neatly captured from Sinumerik — directly via PC, tablet or smartphone

capturing all information from the Sinumerik 828D and Sinumerik 840D sl control systems and using it to generate easy-to-understand graphics on a simple HMI. This solution suited Daliff's needs perfectly. The next step was to understand Daliff's requirements and adapt ncTOUCH to meet them. "We selected the three Leadwell machines with Sinumerik 828D controls and arranged a meeting with Mill IT and Siemens in Cape Town to implement ncTOUCH based around the information and HMI configuration required by Daliff management," explains Christiaan van Schalkwyk, managing director at Daliff.

The software had an immediate effect on Daliff's production: "Already during the first week, analyzing inefficient work processes, poor planning, down-times due to a lack of tools, and so on became straightforward," said van Schalkwyk. The next step in remedying these deficiencies was simple. ncTOUCH has been successful not only from the big brother standpoint of monitoring the machine park but also in the genuine comparison of key production data. It enables set-up times of different types of jobs to be compared with time scales, that is, how long a machine has been in

a certain operating mode (such as job mode or MDI). Daliff now has instant real-time data that can be neatly captured and displayed directly via PC, tablet or smartphone.

Marius Maas, production manager at Daliff, and van Schalkwyk have both given positive feedback on the way that ncTOUCH has impacted the shop. As van Schalkwyk observes, "The data generated in real time are perfectly accurate and therefore cannot be disputed. No matter where in the world the facilities are located, this accurate feedback means there is no room for arguments in production meetings with shopfloor supervisors."

ncTOUCH available as a standard feature

ncTOUCH is now going to be offered as standard on all Leadwell CNC machines with Sinumerik 828D controls purchased through W.D. Hearn Machine Tools in South Africa. W.D. Hearn believes that this software, which offers a genuine edge to customers in monitoring their CNC machine tools, is going to be hugely influential in future sales growth of Leadwell and Siemens in South Africa. <

TECHNOLOGY IN DETAIL

Modern operator interface with ncTOUCH

With ncTOUCH, users can create their own modern, web-based interfaces for Sinumerik 840D sl and 828D, and link these to information and data from the Sinumerik CNC. The provided scripting language allows for quick implementation without any in-depth programming skills. A large number of different templates and ready-to-use applications for ncTOUCH already exist, which can be adapted with ease, from the layout right through to additional functions.

ncTOUCH forms the interface between the Sinumerik CNC and the web browser. Due to the complete integration within the Sinumerik system software, no additional components are required. The programming is done by simply editing normal text files, with no need for a special development environment. Thanks to the integrated networking suite, information from multiple cross-linked machines can be collected on a server, allowing for centralized access, with ncTOUCH handling all of the encryption and data transmission.

INFO AND CONTACT

siemens.com/cnc4you
www.daliff.co.za
robert.schuetze@siemens.com



Technology and financing expertise from a single source

Dual role

Siemens has been accompanying FINOBA Automotive GmbH, based in Baunatal near Kassel in Germany, on its road to success for many years — in two different yet closely related roles: as a technology supplier and also as a financing partner for investments made by FINOBA to steadily consolidate its leading market position.

For FINOBA founder and managing director Guido Barde, the answer to the question of what his company does is really quite simple: “We machine parts. Completely, from a single source, and under one roof.” Founded in 1996, the company is now Europe’s only large-scale provider of complete subcontract machining of structural and chassis parts made of die-cast aluminum and magnesium for lightweight automotive construction.

On a growth trajectory

The company’s strong position is built on the expertise it has developed in the complete machining of die-cast aluminum and magnesium structural and

chassis parts. The company acts as a reliable intermediary between foundries and OEMs in the lightweight automotive production chain, machining and treating die-cast aluminum and magnesium components throughout the completely closed process chain. Whether in the factory for lightweight housings and powertrain parts in Kassel, or in the center of competence for structural and chassis parts in Baunatal, the modern approach of Industrie 4.0 pervades the company’s production sites. This is particularly noticeable in the intelligent networking — from the casting in specialized foundries, to the completely closed process chain from a single source and under one roof at FINOBA, to the just-in-time delivery of ready-to-install components to major

The Audi Q7: The suspension strut supports come from FINOBA, produced with CNC technology from Siemens



AUDI AG



automotive manufacturers. This complete process has many advantages and significantly reduces the number of interfaces in quality management and logistics management.

High pace of innovation

Those who wish to stay ahead of the competition in the components industry cannot afford to take their foot off the gas or slow down the pace of innovation. The drivers of growth at FINOBA are steering the company on a course that focuses on consistent modernization and optimization in the company's traditional business segments. This is also opening the door for new lightweight construction applications — for example, in interiors and powertrain. FINOBA is currently expanding its capacity for large-scale production and is further extending its center of competence for machining structural and chassis parts at the Baunatal site. The completely closed process chain implemented in connection with this development is unrivaled in Europe in terms of its size and degree of vertical integration.

The high-tech highlights of this chain are provided by modern machinery, including automation robots, turning centers and linked CNC five-axis machining centers from Chiron, which are designed for complex machining programs, even on challenging contour shapes. The controls required for high-performance machining and the precise workmanship demanded by the automotive industry are provided by Siemens in the form of industry-leading Sinumerik CNC technology.

Healthy balance sheets thanks to intelligent financing

Innovation not only requires technological excellence; it also needs to be appropriately financed. FINOBA therefore relies on a combination of technology and financing from a single source. Everything the Siemens Digital Factory Division supplies is financed by Siemens Financial Services. A perfect example of this is a new production line for machining suspension strut supports for the Audi Q7 with state-of-the-art Chiron CNC technology and Siemens automation and control technology. Siemens Financial Services financed the investment volume of around €4.4 million.

The decision to finance investments in equipment and machinery by leasing, therefore conserving both equity capital and liquidity, is contributing to healthy balance sheets at FINOBA. “The Siemens Financial Services staff who support us know our business and the market, respond very quickly to new challenges,



FINOBA-AUTOMOTIVE GmbH

“The Siemens Financial Services staff who support us know our business and the market, respond very quickly to new challenges, and show themselves to be highly qualified advisers when it comes to questions of residual value management, value patterns or risk structure adjustment.”

Nicole Boguslawski,
Authorized Representative and Commercial Director,
FINOBA

and show themselves to be highly qualified advisers when it comes to questions of residual value management, value patterns or risk structure adjustment,” says Nicole Boguslawski, authorized representative and commercial director at FINOBA. <

INFO AND CONTACT

siemens.com/cnc4you
petra-anna.goebel@siemens.com



Sinumerik high-level programming language: The WRITE command

Logging made easy

Programs frequently measure values that need to be archived for further processing or even just for logging purposes. With the high-level command WRITE, this action can be done directly from the user program.

With the WRITE command, sets and data from the parts program can be written at the end of a specified file (log file) or the parts program currently being executed. The data are inserted at the end of the file after M30. Alternatively, the data can be saved in a separate file directly onto a network computer or external data carrier.

Structure of the WRITE instruction

The WRITE instruction contains the command invocation and, as parameters, the return variable, the filing location, the name of the file, and the text outputs and instructions that are to be written to the file. The individual parameters are separated by commas.



TIP

The meaning of the return values and further information on the WRITE command can be found in the work preparation programming manual.

```
WRITE(<ERROR>,"</_N_SPF_DIR/_N_
PROTOKOLLE_WPD/_N_PROT_MPF>"|"
<ExtG>","<BLOCK / DATA>")
```

- Invoking the WRITE command**
- Name of the variable for returning the error value**
This variable must be defined before the function call-up: DEF INT ERROR
- Filing location and logging file path**
_N_SPF_DIR:
Directory in the NC
(SPF = subprogram file, MPF = main program file)
_N_PROTOKOLLE_WPD:
Folder in the directory selected above
_N_PROT_MPF:
Name of the log file with file extension MPF or SPF
The file name may contain only letters, numbers and underscores
- Among the instructions, variables/parameters can also be called up in addition to text. These variables could contain the date, time, axis positions and measurement parameters, for example
- Alternative ExtG:
Specification of external data carrier
Must be defined in advance with EXTOPEN. Example for the filing location:
NC/SUBPROGRAMS/PROTOCOL/PROT.MPF



Trier University of Applied Sciences teaches students using Sinumerik CNC and NX software

Teaching and practice — hand in hand

A particular priority of the professors at Trier University of Applied Sciences is to teach techniques and processes that will be essential to the students later on in “real” life in industry. For this reason, they provide the future engineers with a machine park containing modern CNC machine tools equipped with Sinumerik 840D sl as well as a CAD/CAM room equipped with NX CAM.

Future engineers should be taught as much practical knowledge as possible during their studies, since the more practice-oriented the course is, the more quickly its learning can be integrated in operational processes. Dr. Peter Gutheil, dean of the faculty of environmental technology at the Birkenfeld Environmental Campus of Trier University of Applied Sciences, has devised a perfect solution. This year the machine park was expanded, with the addition of four modern machine tools. The most recent acquisition is the Spinner TC600 turning center with the Sinumerik 840D sl CNC. This was especially important for the teachers because, in addition to the Sinumerik CNC, the CAD/CAM software NX CAM, which is also from Siemens, is used for teaching purposes.

All programming methods are taught

Teaching industrial practice also means focusing the training on the different methods of CNC programming. The Sinumerik 840D sl, with the operating and programming software Sinumerik Operate, offers the right range of functions for this and is suitable for all applications and industries.

The graphical programs ShopTurn for turning and ShopMill for milling are op-

tionally integrated for the programming of individual parts. ShopMill and ShopTurn programming is characterized by its high ease of use. The programs can be supplemented at any time with sequences from DIN/ISO programs. This makes it possible to achieve maximum flexibility in workpiece programming. Sinumerik Operate offers the programGUIDE program editor as part of the standard version. If necessary, DIN/ISO codes can simply be written with programGUIDE and then supplemented with an extensive inventory of standard machining cycles.

“Having both methods in one control system increases flexibility tremendously,” emphasizes shopfloor foreman Christian Seibert. The process and environmental technology faculties continually require various valves or other spare parts. But complex components are occasionally in demand for campus presentations, too. Seibert then programs these directly on the machine: “With ShopMill, Sinumerik Operate provides me with a very intuitive programming interface. It allows me to generate every program in a targeted way, without errors, and much more quickly

Siemens AG

SIEMENS PLM SOFTWARE EDUCATIONAL SUPPORT PROGRAM

The Siemens PLM Software educational support program supports more than 12,000 academic institutions around the world. It provides a wide variety of educational institutions — from secondary schools to universities to special research programs — with software solutions such as NX, Solid Edge, Tecnomatix, Teamcenter and Femap. With the PLM and CAD/CAM/CAE software solutions, educational establishments have the best conditions for teaching the students hands-on knowledge of digital product design, simulation, analysis, production and product data management.

If you would like to find out more about the Siemens PLM Software training support program, please contact Karl Hermann Dietz (karl.dietz@siemens.com) or take a look at the website siemens.com/plm.

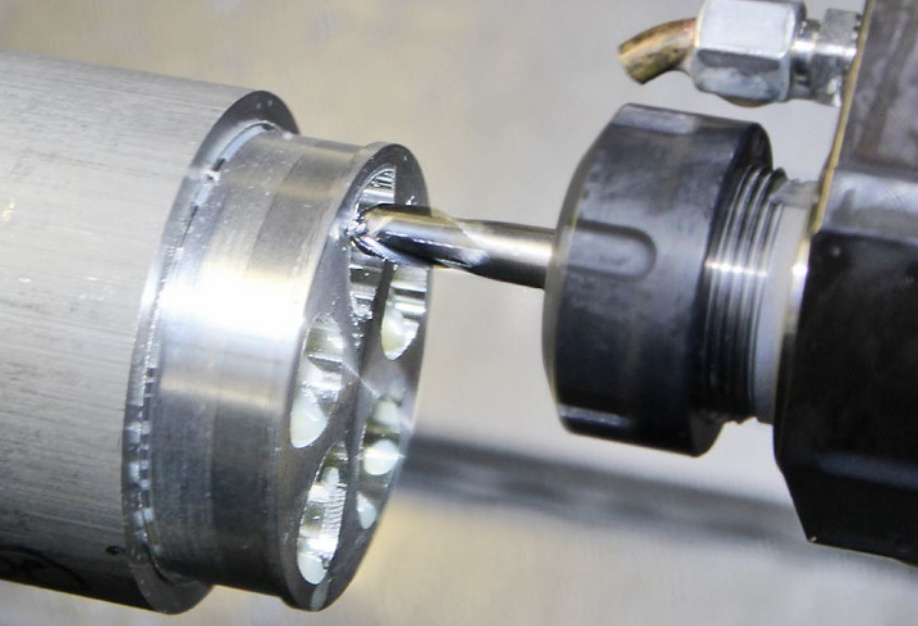

During the machining process, the students can see how their component ideas become reality in the Spinner TC600 turning center

University lecturer Stefan Hirsch transfers CAD/CAM data to the Sinumerik CNC



Siemens AG

than using conventional G-code entry or CAD."

Diverse design possibilities using CAD

The environmental campus has also been using the NX CAD/CAM program from Siemens PLM since 1996. Those in charge are very satisfied with the continuing improvements and developments. "This results in an enormous variety of design possibilities," stresses Gutheil, adding, "Depending on the semester and the amount of interest, the students can learn everything from standard CAD to the finite element method to CAM and even postprocessor programming." Before the programs are transferred to a machining center on the shopfloor, a simply structured simulation can be accessed — a standard feature of NX. Stefan Hirsch, teacher of special tasks at the Birkenfeld university site, also finds this feature very helpful: "Especially during the first semesters, our students sometimes design without consideration for what is feasible. But thanks to the simulation, they can learn where they have made mistakes and how they can avoid them in the future."

Learning how designs are implemented with CAD/CAM systems is one thing. But it is just as important to

know how the individual parts of the design are machined later in machining centers. "Companies expect even young engineers to understand the entire production process and know what is technically feasible," explains Hirsch. "That includes working with CAD/CAM systems as well as having knowledge of the performance of machine tools."

Continuous process chain

The consistency of both the Sinumerik CNC and the NX CAD/CAM software makes work easier for the lecturers as well as the shopfloor supervisors. The tools the TC600 machine is fitted with, as well as cycles such as Cycle800 (swiveling), Cycle832 (high-speed settings) and various drilling cycles, are integrated in NX and are transferred together with the program to the control system via the postprocessor. Hirsch is extremely impressed: "I only have to enter the corresponding data once, and now they are available for every component to be produced."

To ensure that his technology-oriented students also learn with a practical orientation during the theory semesters, he provides them with computers with modern NX9 CAD/CAM software from Siemens on which they can translate their ideas into designs. The campus re-

ceived around 100 licenses for this purpose through the Siemens PLM Software educational support program. The major advantage of this approach is that the engineers-to-be learn how to work with computer-based design software while still at the university. The professor identifies an additional benefit in that NX is a standard part of work preparation in many industries, such as automobile and aircraft manufacturing, and medical technology: "We work with many well-known companies that use NX and particularly appreciate the flexibility and openness of this software." As the system has proven itself so well, Gutheil can envisage adding to the existing 100 NX licenses in the future. This training philosophy at Trier University of Applied Sciences is an example of how it is possible to successfully collaborate with strong partners in industry to implement a perfect basis for practice-oriented teaching of engineers. <

INFO AND CONTACT

siemens.com/cnc4you
alois.penzkofer@siemens.com

eBooklet for EMO 2015

Reliable trade fair companion

Visitors to EMO 2015 in Milan can download an eBooklet onto their smartphone, tablet or PC to serve as a useful companion before, during and after the trade fair.

Perhaps you have thought about viewing a machine for gear cutting or recommending a visit to a certain machine in the run-up to the trade fair. The EMO 2015 eBooklet from Siemens — an electronic reference guide available via a standard browser — gives you access to more than 150 machine tools with Sinumerik that will be showcased at this year’s EMO.

Are you thinking of planning your trade fair visit ahead of time? A simple machine search function allows you to filter the results by manufacturer and hall using a text search tool and quickly guides you to the right machine.

Perhaps you are already at the trade fair and would like to know which machines are located in the hall you are currently in — for instance, only machines equipped with Sinumerik 828D. The results filter can help in this situation, allowing you to select the relevant components, industries and machine types in addition to the manufacturer and hall.

Or do you want to create a favorites list of machines for a colleague that is available offline for you at the fair? The offline favorites list enables you to save up to 10 selected machines with descriptions and images. You can also share and recommend individual entries from a favorites list by e-mail, Twitter, WhatsApp, and so on, directly from the trade fair.

siemens.com/emo-ebooklet

EMO trade fair show — smart operation



Siemens is highlighting the motto “On the Way to Industrie 4.0 — Digitalization in Machine Tool Manufacturing” with an interesting and exciting show at the company’s EMO booth. The show reveals how digitalization can specifically benefit shopfloor applications with smart operation. Two actors invite visitors to delve into the digital world of smart operation and represent the individual smartPrepare, smartOperate, smartMobile and smartIT solution packages. A large touchscreen acts as a membrane between the digital world and reality, which then merge to become a single entity.

Visit Siemens in Hall 3 and see for yourself the solutions available for digitalization in the machine tool industry.

siemens.com/emo

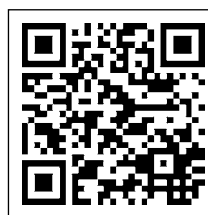
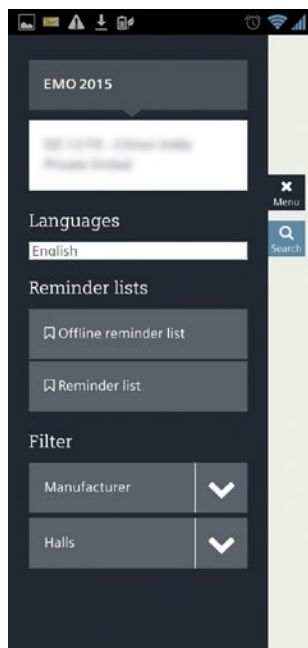

First scan the QR code and then download the eBooklet



Siemens AG

Participants at the first Siemens-Weiss spindle workshop were given extensive information about spindles

Successful spindle workshop

Siemens subsidiary Weiss Spindeltechnologie held its first spindle workshop at the company's service center in Maroldswisach, Germany, at the be-

ginning of this year. Production personnel responsible for machining and machine tools at a wide variety of Siemens sites were invited to attend the event, and participants were welcomed from almost every region of the German-speaking Siemens world. Oskar Neuner, head of customer care in repairs and service at Weiss, was delighted with the workshop's success. "It was all about showing the participants the wide range of services for motor spindle units that we are able to offer within the Siemens family, as well as the kinds of strategies that can be employed to minimize machine downtimes," says Neuner. "The members of our product management team also brought their Siemens colleagues up to date with the latest developments in motor spindle technology."

In addition to a tour of the company's premises and a presentation on the latest product and service portfolio from Weiss, the agenda for the first workshop included an overview of the repair

process on-site. Attendees also compared notes on maintenance and many other spindle-related topics. The spindle specialists at Weiss will be incorporating these expert responses into the services they offer in the future, thus enabling them to provide even more focused support for their end customers.

Based on the positive feedback for the first Siemens-Weiss spindle workshop, the organizers have decided to hold more events of this kind at regular intervals. The next event will focus on harnessing existing potential for condition monitoring for motor spindle units. Those interested in participating are invited to sign up now at service@weissgmbh.de.

INFO AND CONTACT

siemens.com/cnc4you
juergen.klingler@siemens.com

New learning factory with Sinumerik

Berlin Adlershof is one of the largest science parks in the world. Covering an area of 4.2 km², the park is home to research institutions, institutes and numerous companies — and now also to the learning factory Lernfabrik Neue Technologien Berlin. When the learning factory opened its modern technology and training center on May 27, 2015, a dream became reality for Michael Bose

and Evelyn Schmidt. The project is financed by a privately funded nonprofit limited company, with the support of industrial companies. Siemens is part of the network as one of the project partners. "We are an approved Siemens training partner," says Schmidt. Siemens representatives Andre Zänker and Enrico Ehrhardt from Chemnitz took the opening ceremony as an opportu-

nity to present Bose and Schmidt with the recognized CNC training partner certificate.

Since April the learning factory has been training young metalworkers as CNC specialists using brand-new CNC equipment from DMG Mori. The learning factory has no intention of being just another educational provider. "We want to work with and for industry in order to train our participants as they work on real orders," says project manager Schmidt.



Siemens AG

Andre Zänker (right) from Siemens presents the CNC training partner certificate to Evelyn Schmidt and Michael Bose

INFO AND CONTACT

siemens.com/cnc4you
enrico.ehrhardt@siemens.com



SIEMENS



Show and presentations at the Siemens booth

EMO Milan
October 5-10, 2015
Hall 3, E06 / F03

Digitalization in Machine Tool Manufacturing

siemens.com/emo

Increased efficiency, enhanced flexibility and shorter time to market – all this is promised by digitalization. Whether integrated engineering in machine development or networking machine tools in a production landscape:

We support machine builders as well as machine tool users with our solutions! The basis is always our SINUMERIK® CNC with its openness and technological bandwidth.

